

## technical sheet

SCALE: 1/8 INCH = 1 FOOT (1:96)  
 Each piece is made by hand and has its own uniqueness.  
 Measures may vary with a tolerance up to 4%

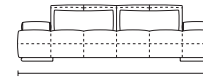

251 cm - 99'  
**PARAMOUNT D3**

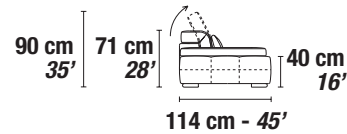
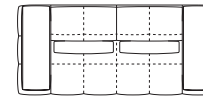

### STANDARD FEATURES

Hard wood frame - Reinforced and crossed elastic Pirelli webbing.

Seat depth 52 cm - 20' inches

Seat height 40 cm - 16' inches

Loose lumbar support and tight arm cushions.

Legs PL51 - Height 4,5 cm - 1'3/4 inches.

Double needle stitching / Heavy duty needle stitching

Units with back cushions features a headrest mechanism with can be lifted up individually.

Leather thickness from 1.4 up to 2.4 mm.

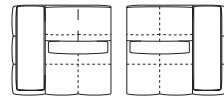

126 cm - 50' 126 cm - 50'  
**S13 PARAMOUNT D13**

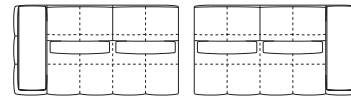

208 cm - 82' 208 cm - 82'  
**S03 PARAMOUNT D03**



84 cm - 33'  
**PARAMOUNT E11**

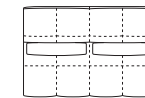

166 cm - 65'  
**PARAMOUNT E15**

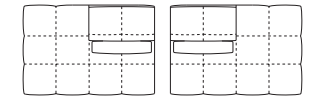

166 cm - 65' 166 cm - 65'  
**S17 PARAMOUNT D17**

### OPTIONS

Throw pillows

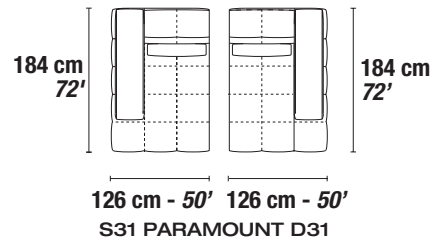

126 cm - 50' 126 cm - 50'  
**S31 PARAMOUNT D31**

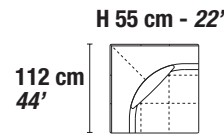

112 cm - 44'  
**PARAMOUNT E01**

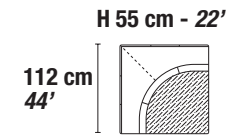

112 cm - 44'  
**PARAMOUNT CON**

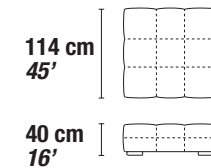

114 cm - 45'  
**PARAMOUNT EV4**

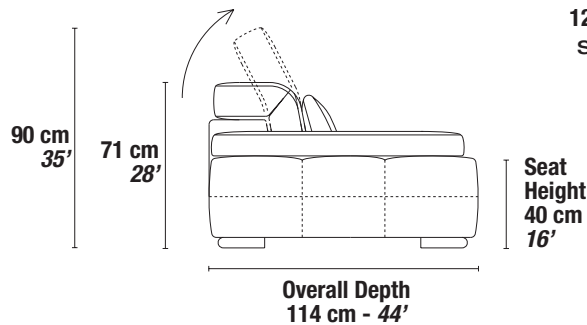

NOTE : CON - CORNER TABLE WITH WOOD TOP